

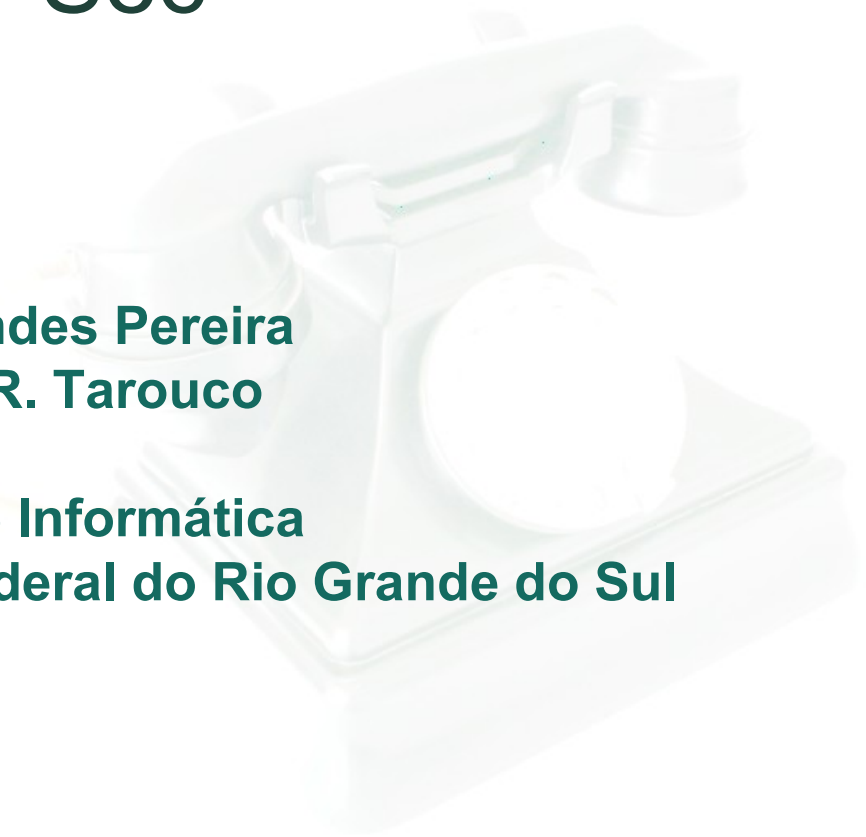

Solução Adaptativa para Multiplexação com QoS de Ligações VoIP sobre IPSec

Rafael Mendes Pereira
Liane M. R. Tarouco

Instituto de Informática
UFRGS - Universidade Federal do Rio Grande do Sul



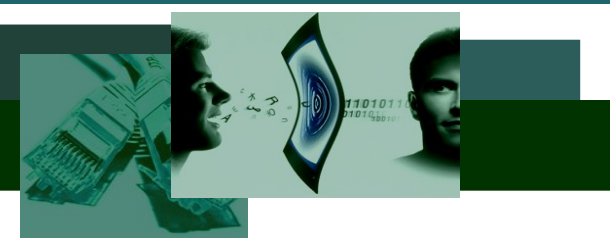

Roteiro

- **Introdução**
- **Sucesso e Requisitos VoIP**
- **IPSec: Vantagens e Overheads**
- **Multiplexação**
- **Solução Adaptativa**
- **Experimentos e Resultados**
- **Considerações Finais**





Sucesso VoIP

- **Baixo Custo, Flexibilidade, Novos Recursos (Dados, Vídeo, etc)**
- **Usuários Domésticos e Corporativos**
- **Projeção:**

“Até 2010 mais de 80% do tráfego de voz e dados será por meio de VoIP!”

TelComp (Associação Brasileira das Prestadoras de Serviço de Telecomunicações Competitivas)

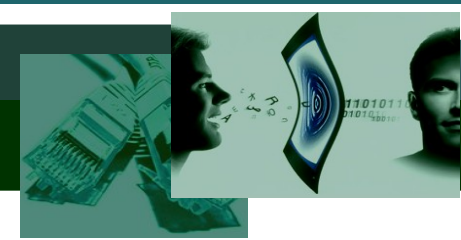

Requisitos

Banda

QoS

Segurança





Riscos

- **Vulnerabilidades: Sinalização e Mídia**
- **Interceptação e escuta indevida**
- **Alterações**
- **Degradação do Serviço (DoS)**





Segurança em VoIP

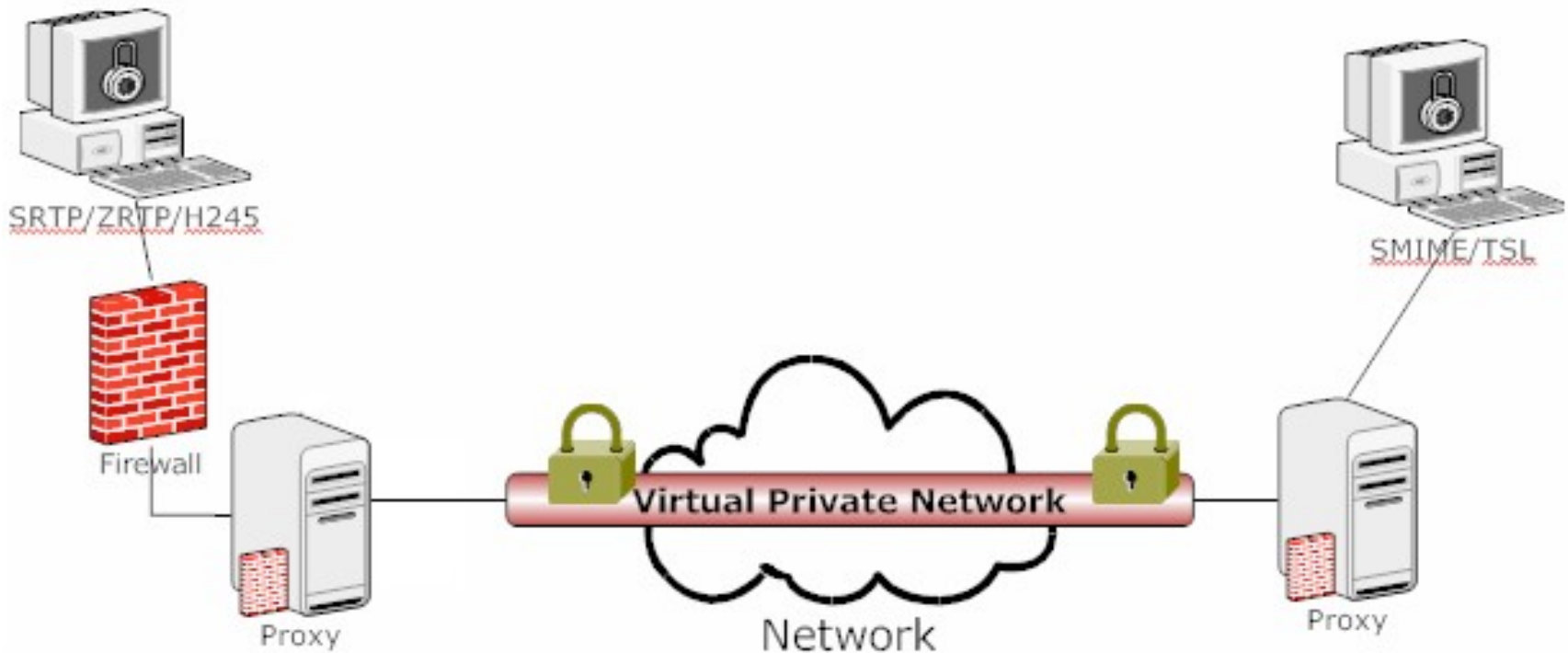

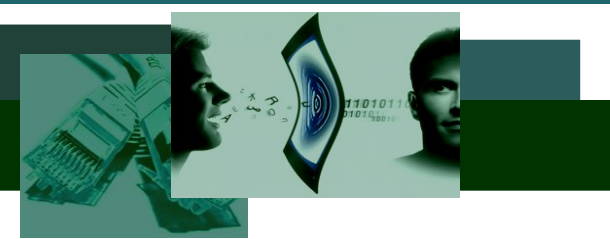

IPSec

- Segurança para o protocolo IP;
- *Security Association (SA)*;
- Modo:
 - Transporte;
 - Túnel.
- Cabeçalhos:
 - AH (*Authentication Header*):
 - Integridade, autenticação e anti-replay.
 - ESP (*Encapsulation Security Payload*):
 - Privacidade, integridade, autenticação e anti-replay.



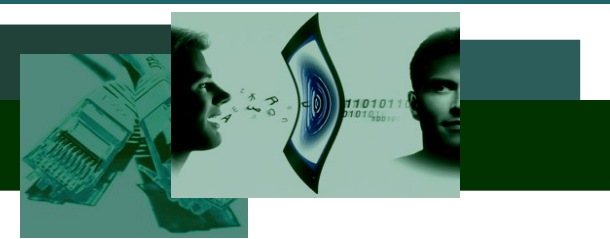

IPSec – expansão dos pacotes

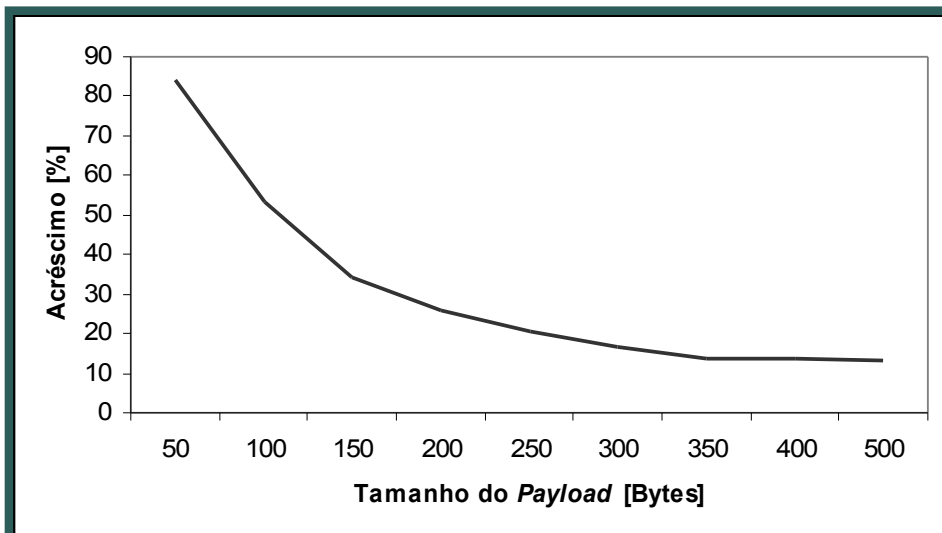
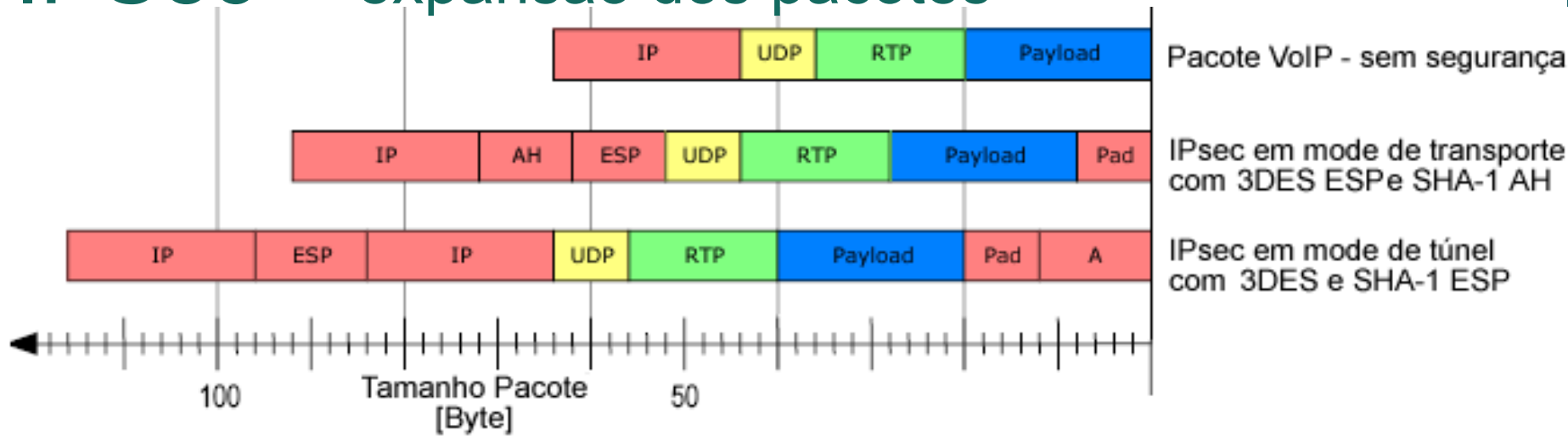

Diminuição de até 40% da capacidade do número de ligações simultâneas!

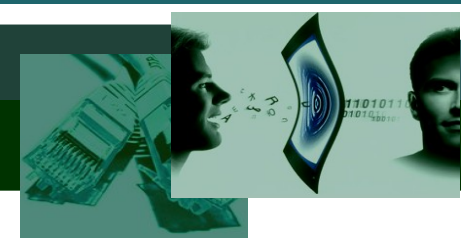

Compressão de Cabeçalhos

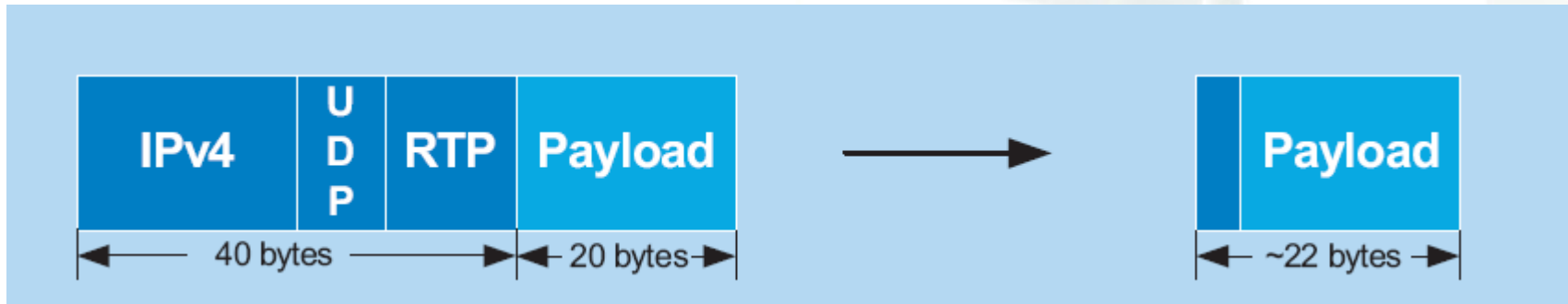
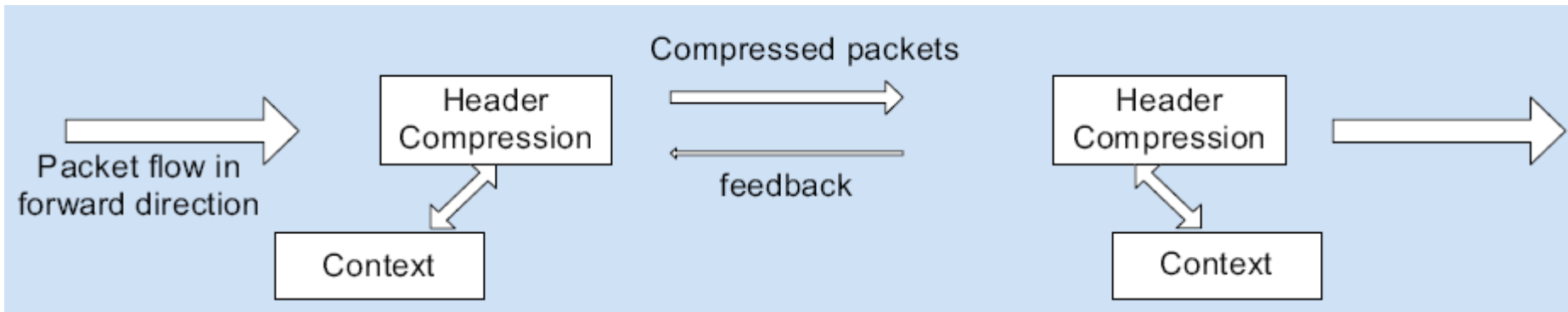

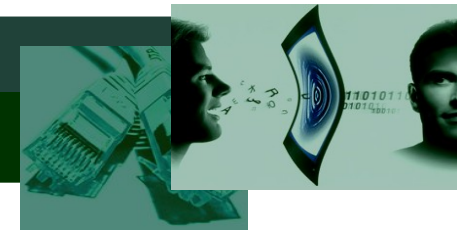

Multiplexação

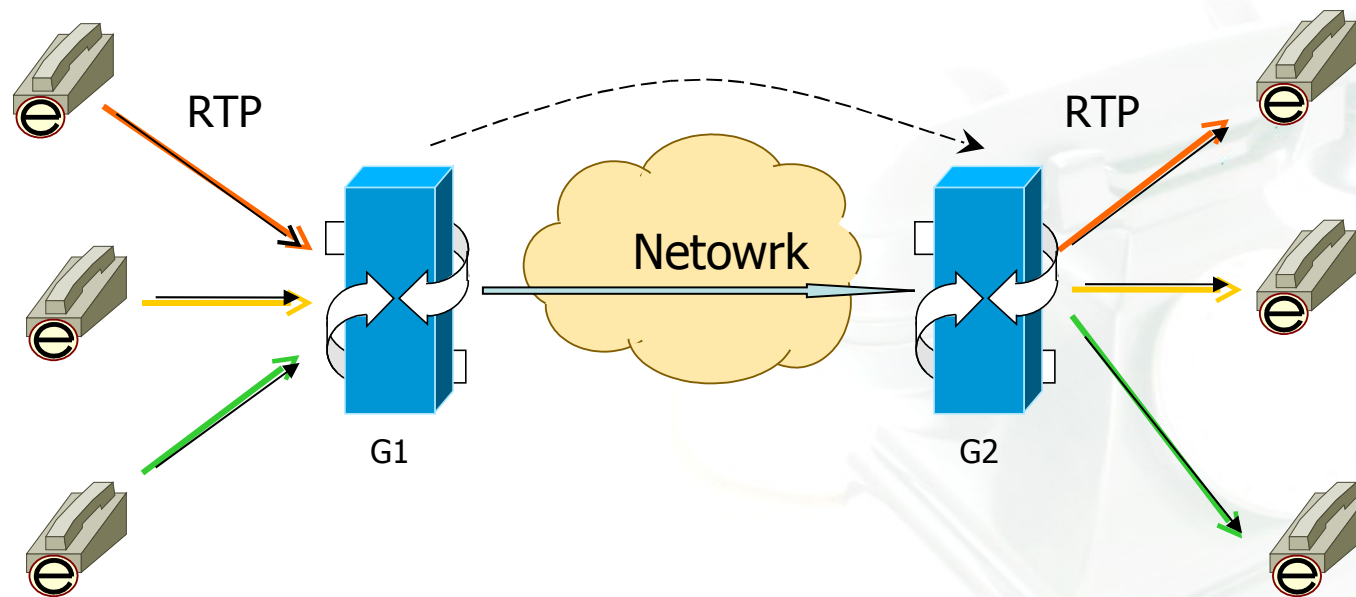

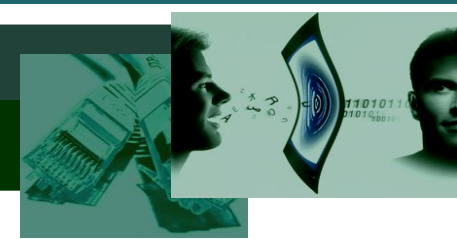

Multiplexação – IPSec

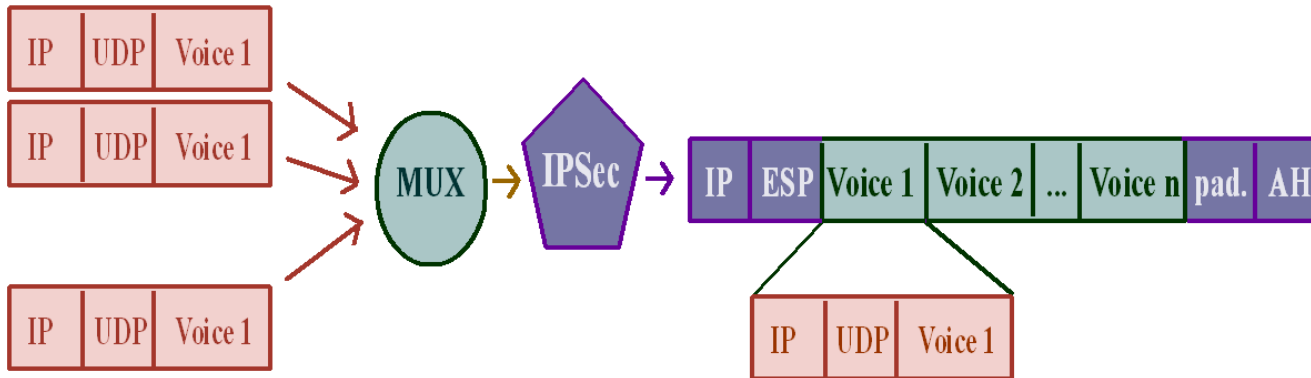
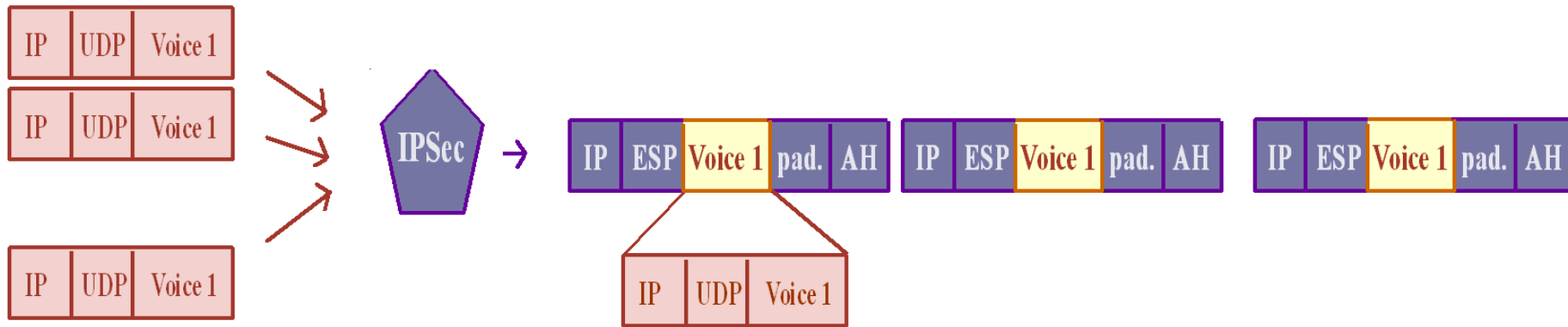



Multiplexação – Tempo de Retenção

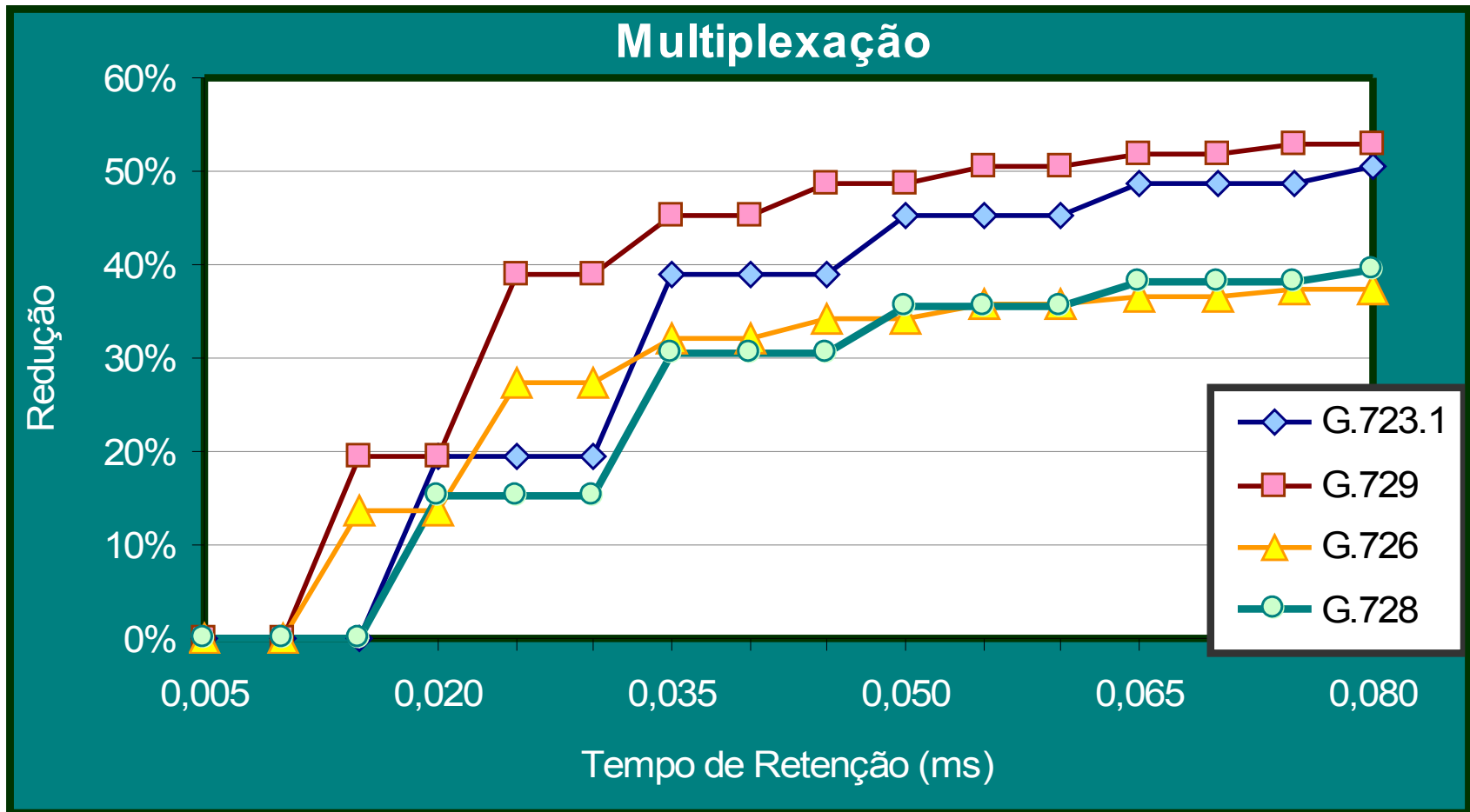

10 Ligações Simultâneas

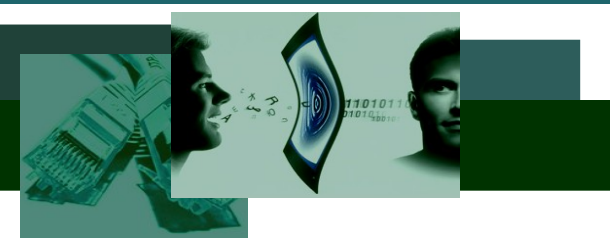

Multiplexação – Impactos

- Razão: redução X atraso!
- Aumento do atraso total (fala e escuta)
 - Codec+Empacotamento+Rede+Buffers+etc
 - Recomendado: 150ms – 300ms
 - Limite variável!

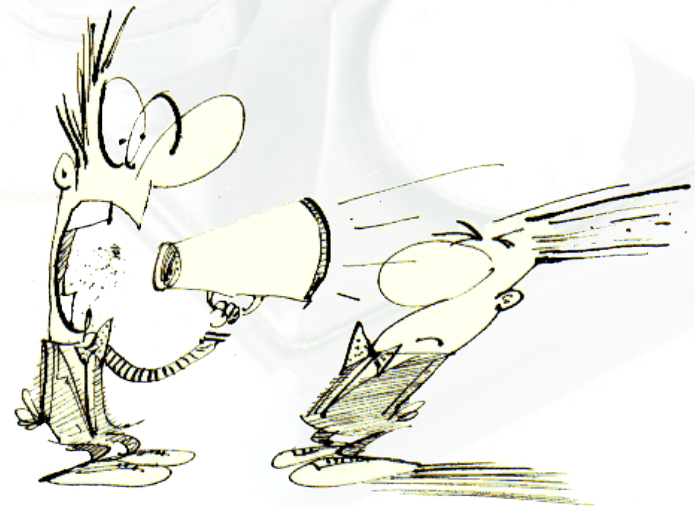

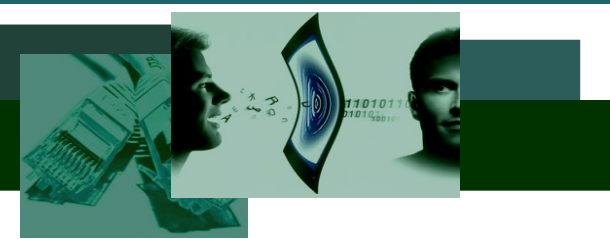

Impacto com Atraso

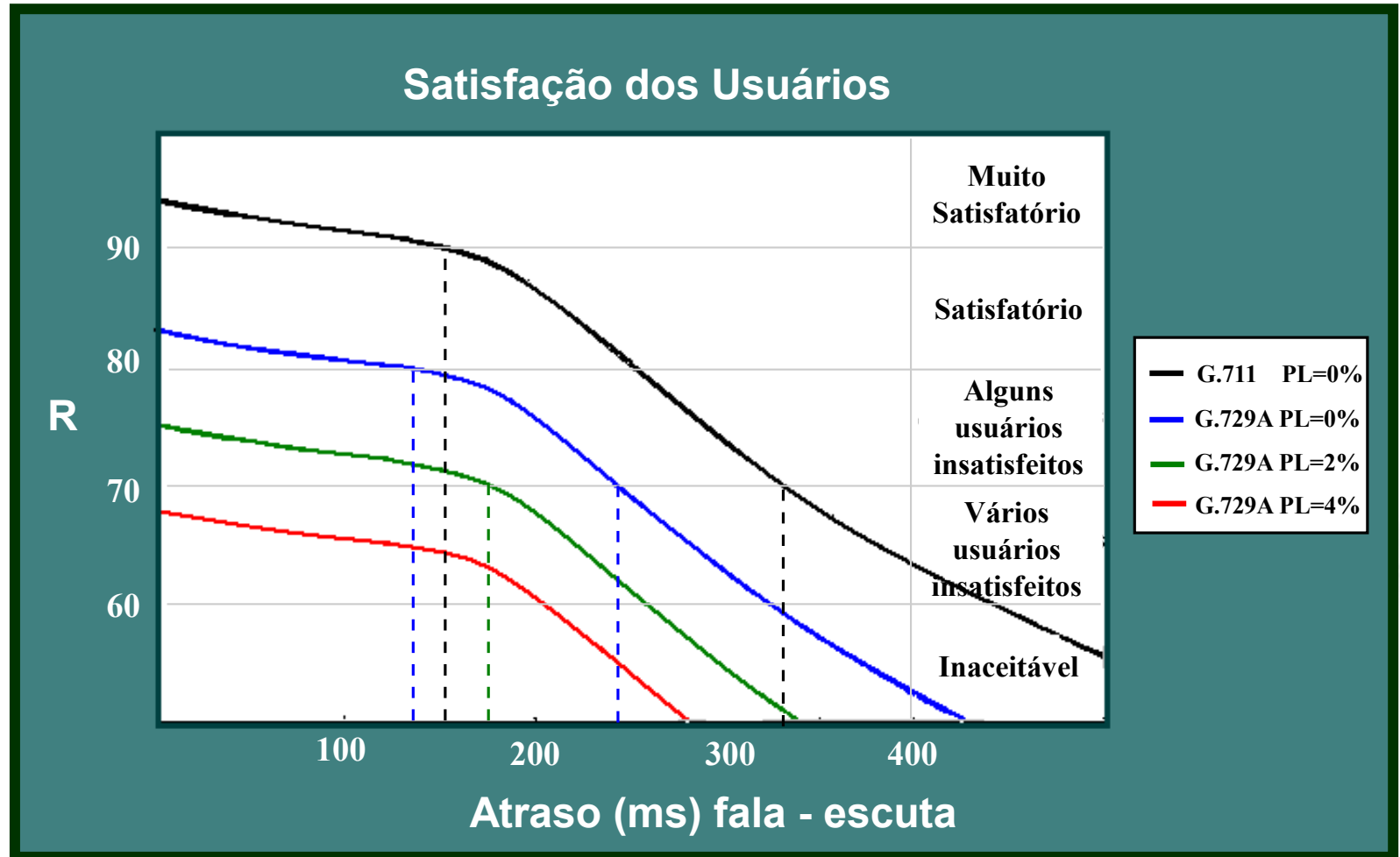

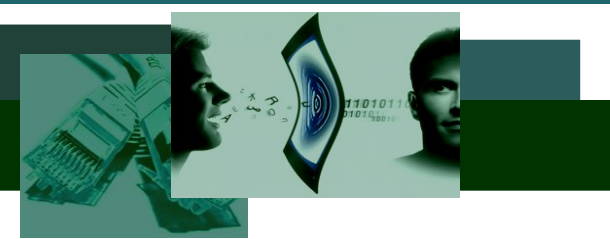

Multiplexação – Impactos

- Ligações com diferentes parâmetros
 - Codec
 - Atraso (intercontinentais, satélites)

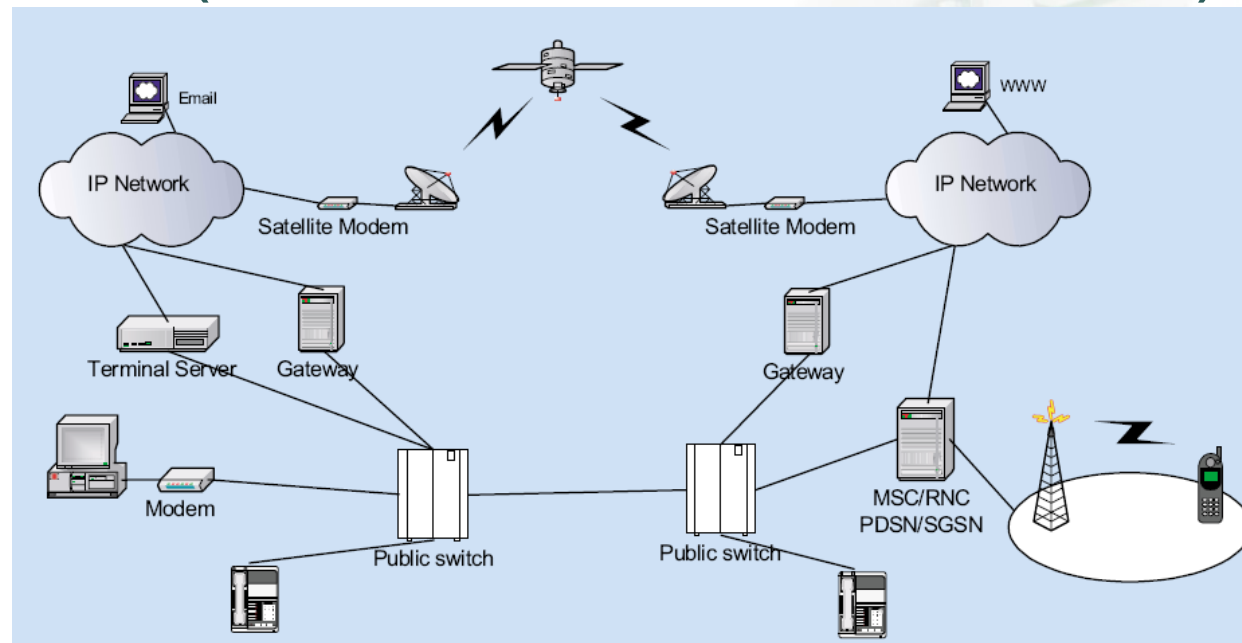

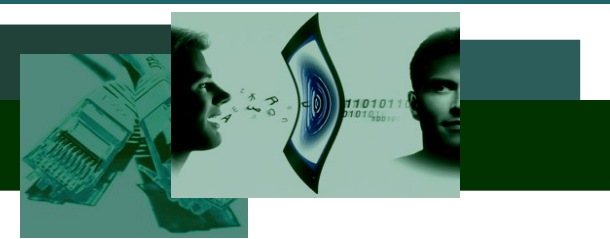

Desafio – Tempo Ideal de Retenção

- Possibilitar a diminuição do impacto da expansão dos pacotes com o IPSec;
- Manter o nível de qualidade
 - Respeitar:
 - Diversos fatores de degradação
 - Distintos requisitos de todas as ligações multiplexadas.

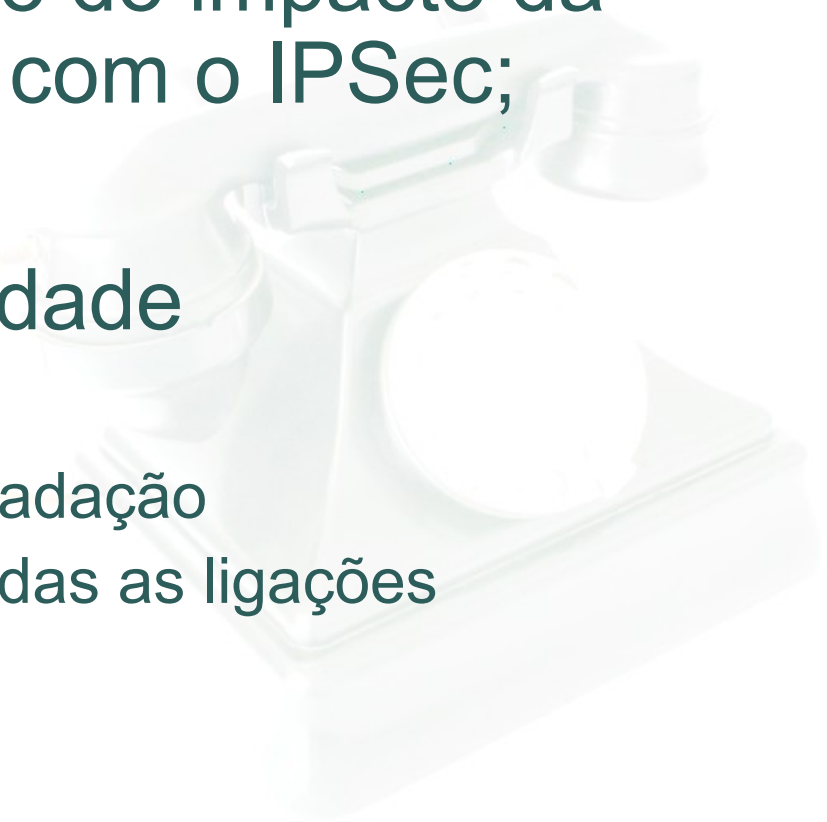

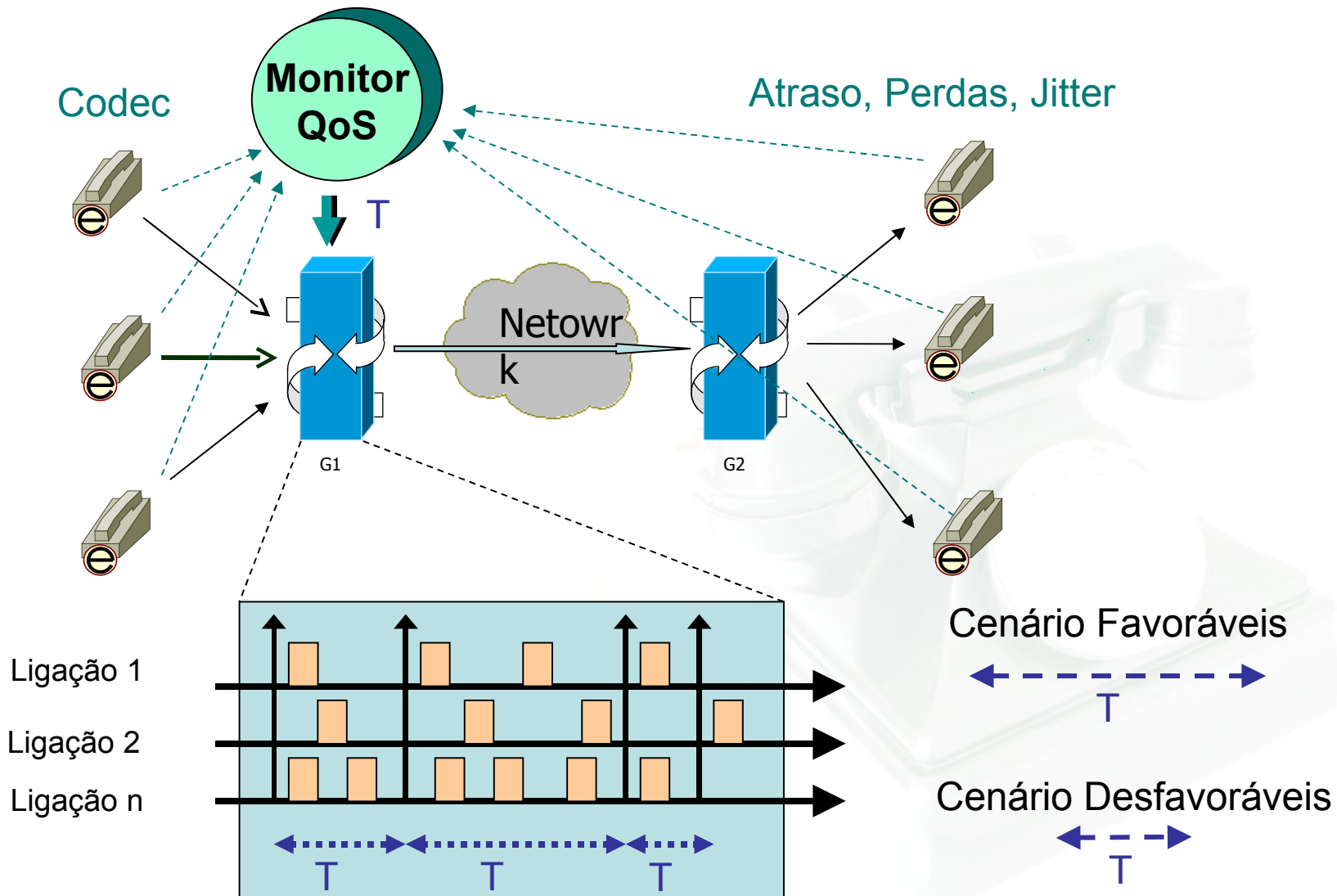



Emodel

$$R = R_o - I_s - I_e - I_d$$

- R_o** - Relação sinal ruído básico
- I_s** - Fator de perdas simultâneas
- I_e** - Fator de perdas com equipamentos
- I_d** - Fator de perdas com atraso

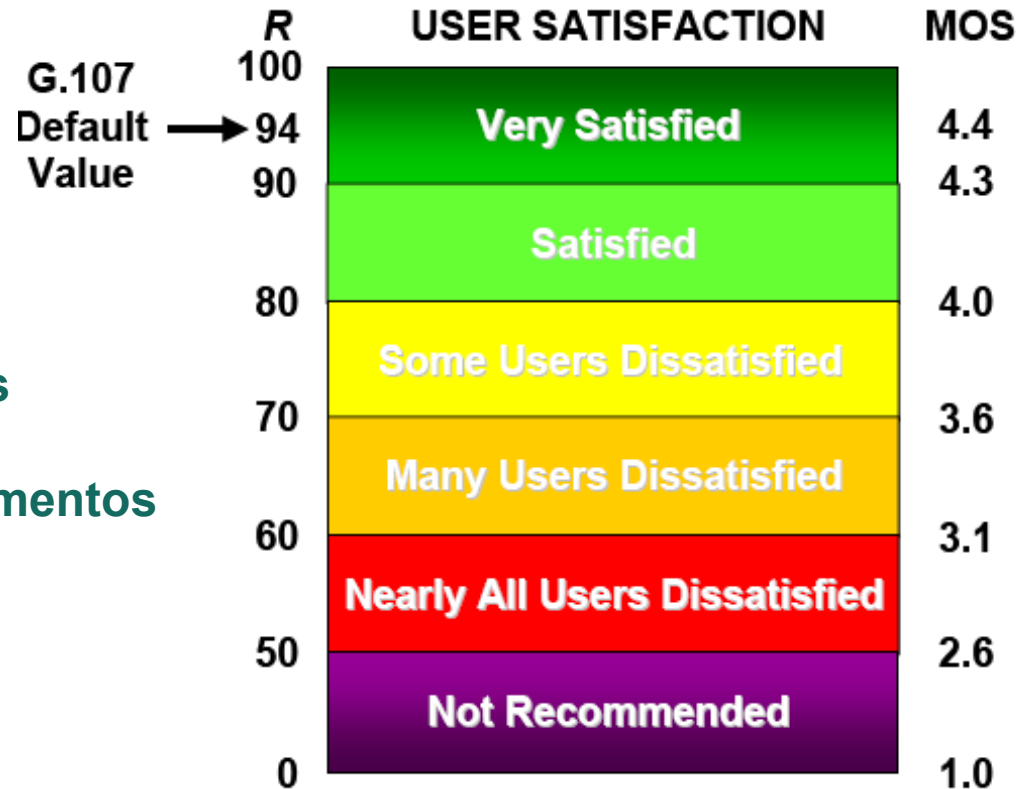

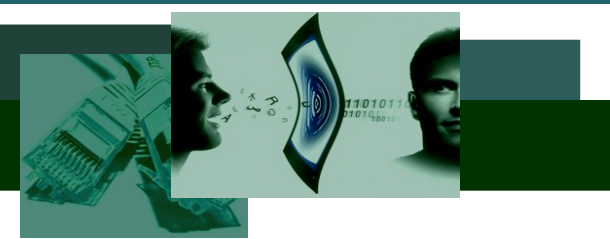

Simulações

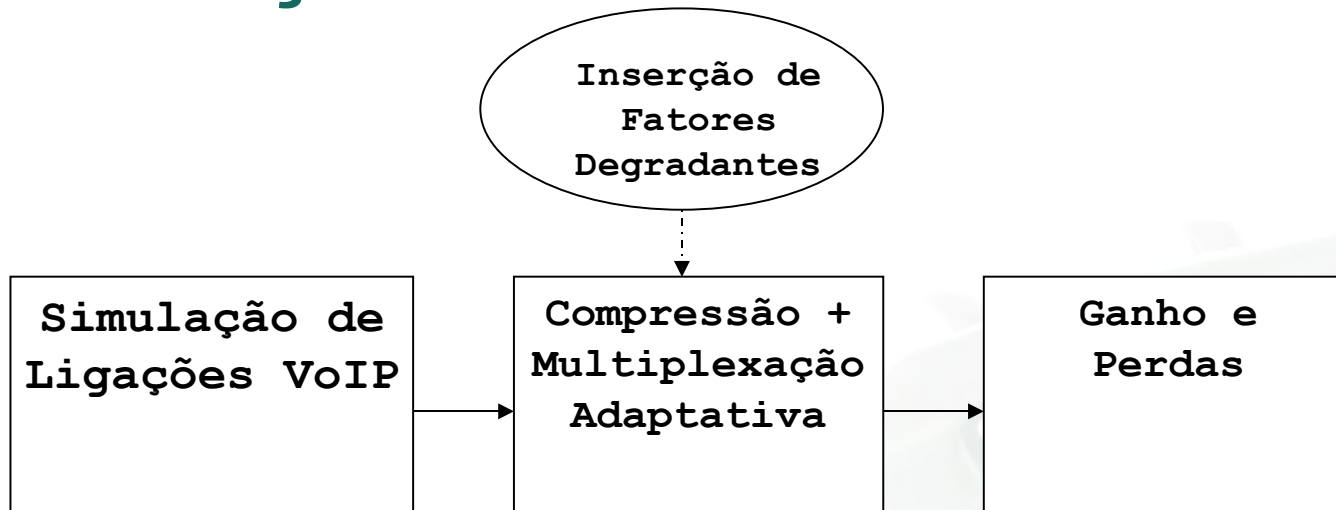

- **Comparação:**
 - Tempo de retenção fixo (1 frame em ms):
 - 10, 20 e 30 ms.
 - Avaliação:
 - Redução do overhead
 - Qualidade das ligações



Resultados - Cenários Favoráveis

Ganho

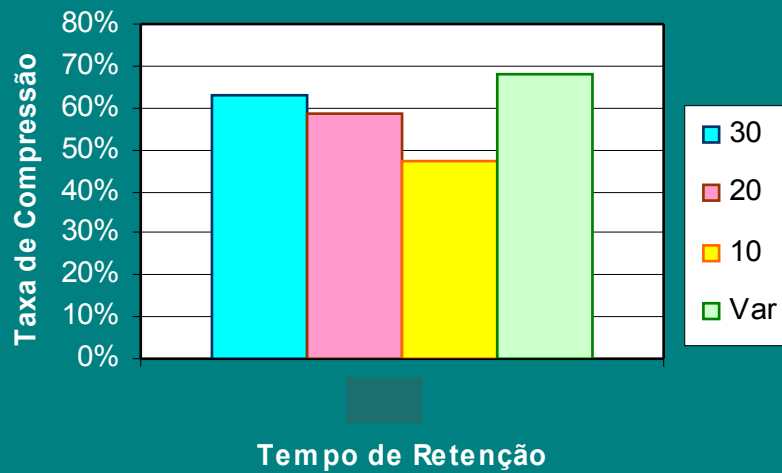

Qualidade da Ligação

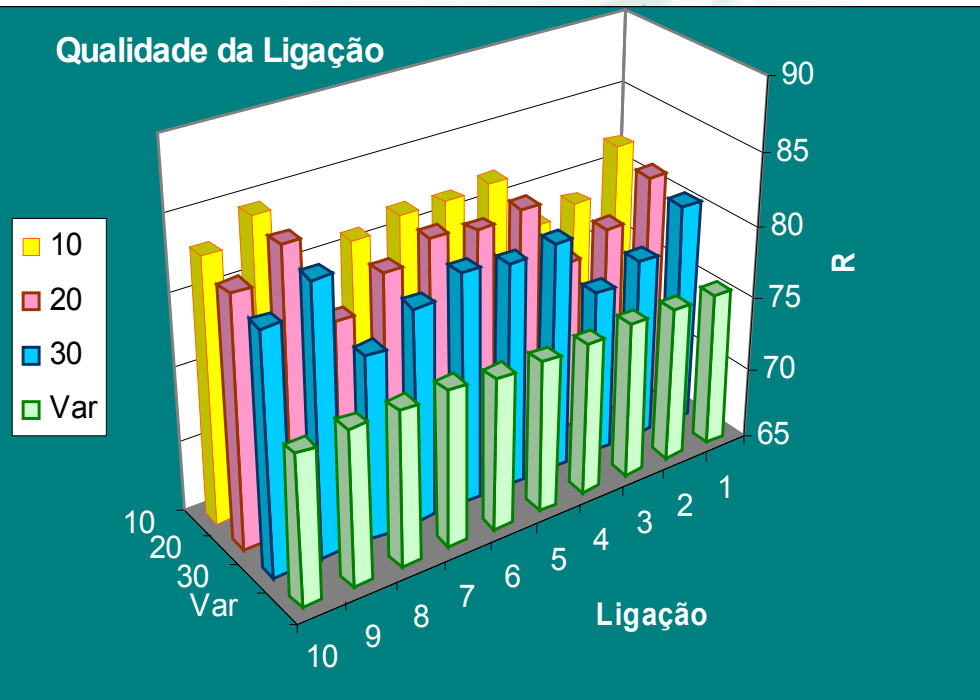



Resultados - Cenários Desfavoráveis

Ganho

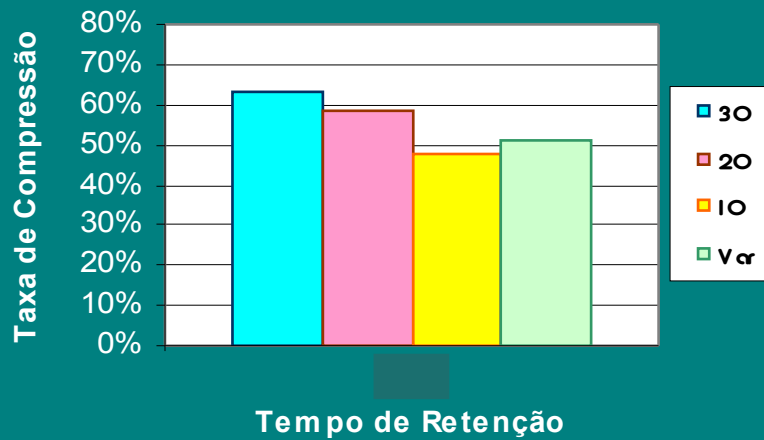

Qualidade da Ligação

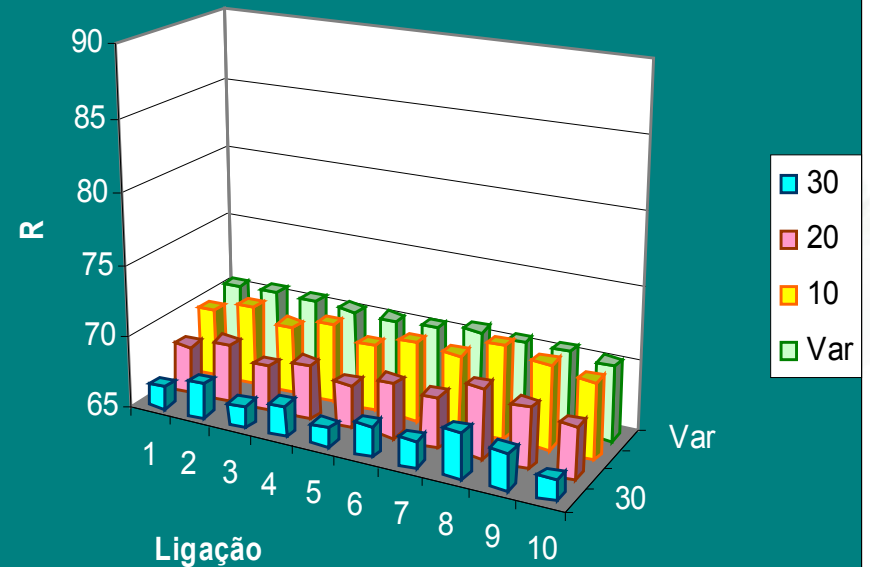

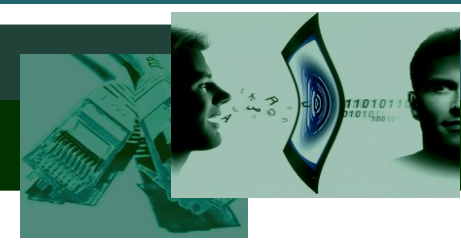

Resultados - Cenários Desfavoráveis

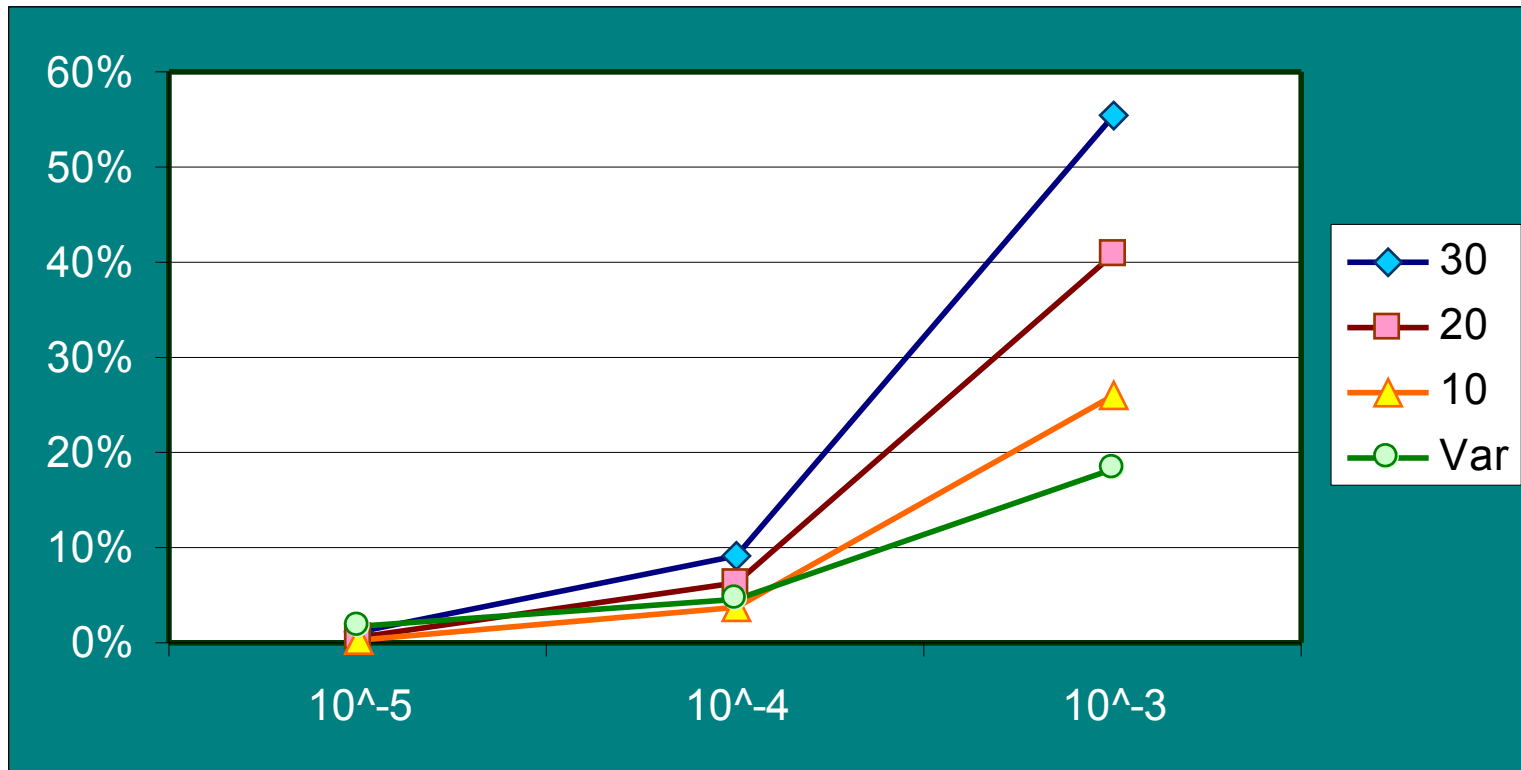

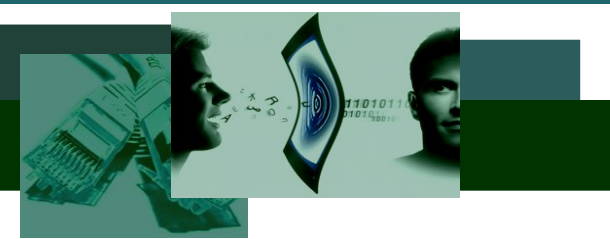

Considerações Finais

- Solução robusta
- Justa com as ligações
- Possibilita VoIP com:
Segurança + Banda + QoS



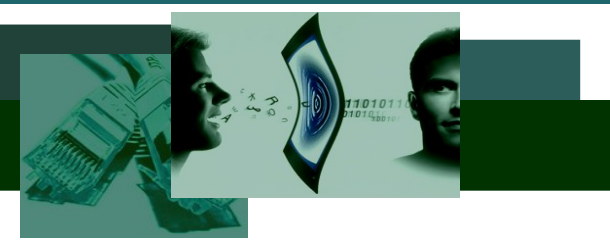

Obrigado!

**Rafael Mendes Pereira – rmpereira@inf.ufrgs.br
Liane M. R. Tarouco**

